

# DHT82EIN







Produktkategorie	Trockner
Breite	60 cm
Installation	Freistehend
Trocknungssystem	Kondensation (Wärmepumpe)
Beladungsart	Frontlader



## Programme / Funktionen

Bedienungsart	Elektronisch
Programmgrafik	Schriftzug (EN)
Anzahl der Trockenprogramme	16
Multilinguales Sprachen-Clip System	Ja
Schriftzüge/Sprachen-Clip	(DE)/ (FR)/ (NL)/ (PT)/ (SE)/ (DA)/ Nein/ (FI)/ (PL)/ (UA)
Zeitprogramme	Cotone Pronto Stiro, Cotone Asciutto Armadio, Cotone Asciutto Armadio +, Cotone Extra Asciutto, Sintetici Pronto Stiro, Sintetici Asciutto Armadio, Delicati, Refresh, 45 min, 30 min, Camicie, Sport, Baby, Rapido 45 min, Quotidiano, Jeans

### Automatikprogramme

 Baumwolle Bügeltrocken	 Baumwolle Extra-Schrantrocken	 Baumwolle Extra-Trocken
 Synthetik Bügelfertig	 Synthetik Schrantrocken	 Pflegeleicht
 Auffrischen	 45 min	 30 min
 Hemden/Business	 Sport	 Baby
 Täglich	 Baumwolle Schrantrocken	 Schnell 49 min
 Jeans		

## Sonderprogramme



Auffrischen



Pflegeleicht



Schnell 30 min.



Hemden/Business



Sport

## Display

### Display-Typ

Zeitvorwahl, Restlaufanzeige, Programmstatusanzeige



### Anzeige für Programmablauf

### Anzeige für Zyklusende

### Anzeige Filterreinigung

Ja

### Anzeige Entleerung Kondenswasserbehälter

Ja

## Technische Eigenschaften



<b>Motortyp</b>	Standard	<b>Beladungsöffnung</b>	40 cm
<b>Funktion</b>	Elektronische Kontrolle	<b>Max. Türöffnungswinkel</b>	178 °
<b>Restfeuchte-Sensor</b>	Ja	<b>Türanschlag</b>	Rechts
<b>Einstellung der Trocknungstemperatur</b>	Ja, über Programmauswahl	<b>Türanschlag reversibel</b>	Ja
<b>Abkühlphase</b>	Ja	<b>Kindersicherung / Tastensperre</b>	Ja
<b>Funktion Knitterfrei bei Programmende</b>	Ja	<b>Position des Kondenswasserbehälters</b>	Oben
<b>Reversier-Automatik</b>	Ja	<b>Wärmepumpensystem</b>	Ja
<b>Trommelinnenbeleuchtung</b>	Ja	<b>Kältemitteltyp</b>	R134a
<b>Wärmetauscher-Filter</b>	Ja	<b>Kältemittelmenge</b>	0,35
<b>Fussfilter</b>	Ja	<b>Ablaufschlauch für Kondenswasser</b>	Ja
<b>Trommelmaterial</b>	Edelstahl	<b>Säulenfähig auf kompatible Waschmaschine</b>	Mit Turm-Kit
<b>Trommelvolumen</b>	118 l	<b>Sonderzubehör</b>	KITSPXL - Turm-Kit
<b>Klarsichttür</b>	Ja		

## Leistung / Energielabel



<b>Nennkapazität Baumwollwäsche</b>	8 kg	<b>Dauer des unausgeschalteten Zustands</b>	30 min
<b>Art des Wäschetrockners</b>	Wärmepumpenkondensator	<b>Programmdauer des Standard-Baumwollprogramms bei vollständiger Befüllung</b>	179 min
<b>Produkttyp</b>	Kondensation	<b>Programmdauer des Standard-Baumwollprogramms bei Teilbefüllung</b>	104 min
<b>Energieeffizienzklasse auf einer Skala von A+++ (höchste Effizienz) bis D (niedrigste Effizienz)</b>	A++		
<b>Jährlicher Energieverbrauch (AEc)</b>	230 kWh		

Energieverbrauch im Standard-Baumwollprogramm bei vollständiger Befüllung 1,92 KWh  
 Energieverbrauch im Standard-Baumwollprogramm bei Teilbefüllung 1,03 KWh  
 Leistungsaufnahme im Aus-Zustand 0,5 W  
 Leistungsaufnahme im unausgeschalteten Zustand 1 W

Gewichtete Programmdauer des Standard-Baumwollprogramms bei vollständiger Befüllung und Teilbefüllung 136 min

Kondensationseffizienzklasse B auf einer Skala von G (geringste Effizienz) bis A (höchste Effizienz)

Durchschnittliche Kondensationseffizienz des Standard-Baumwollprogramms bei vollständiger Befüllung 91 %

Durchschnittliche Kondensationseffizienz des Standard-Baumwollprogramms bei Teilbefüllung 91 %

Durchschnittliche Kondensationseffizienz des Standard-Baumwollprogramm bei vollständiger Befüllung und Teilbefüllung 91 %

Durchschnittlicher Schalleistungspegel (LWA ) für das Standard-Baumwollprogramm 65 dB(A) re 1pW

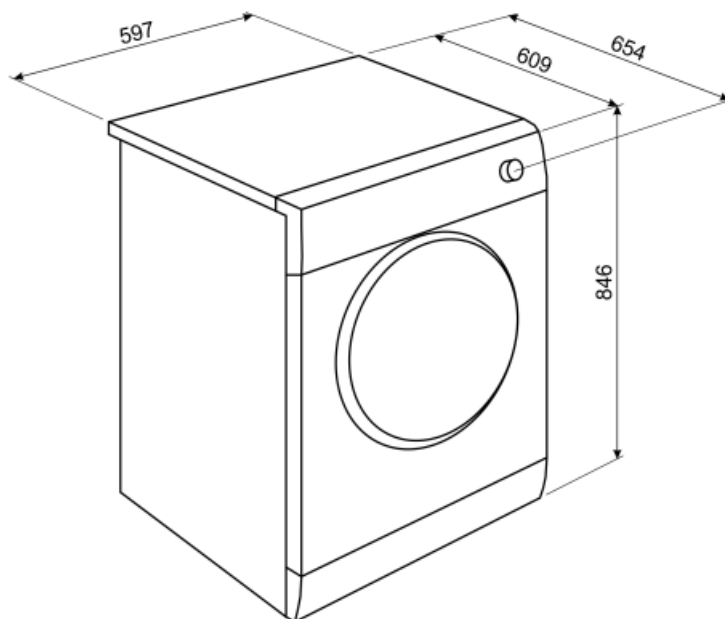

## Not included accessories































---

### KITSPF-1

Universal Stacking kit for washing machine and dryer



## Symbols glossary (TT)

	A++: Energy efficiency class A++ helps to save up to 20% energy compared to class A. Maximum performance with minimum consumption is guaranteed.		Child lock: some models are fitted with a device to lock the programme/cycle so it cannot be accidentally changed.
	Delay timer: can be set to run the programme at a convenient time or to take advantage of off-peak energy periods.		LED display: to show programmes, functions and options selected and the time to the end of the cycle.
	40 cm: Large loading hatch of 40 cm in diameter, makes laundry loading and unloading easier and faster with maximum ease of use.		This shows the amount of laundry that can be inserted into the tumble dryer in KG.
	Humidity sensor: allows to adjust dryer to obtain the desired drying level (Iron dry, Cupboard dry and Extra dry), saving time and reducing energy consumption. In addition, manual adjusting allows you to program drying time according to your preferences.		End: Show the stage at which the program is in progress: the program has finished.
	Internal lights: help to illuminate the inside of the drum.		Noise Level: Excellent insulation and special devices keep noise to a minimum.
	Delicate: Clothing such as underwear, hosiery and luxury fabrics should be dried on the delicate cycle to help extend the life of the clothing.		Timed program for shirts
	Timed program for shirts		Specific for child garments
	Cupboard drying for cotton garments		Extra cupboard drying for cotton garments
	Extra drying for cotton		Drying of cotton garments that need to be ironed
	Specific for daily drying of cotton or synthetic garments		Delicate garments that allows the drying
	For high speed centrifuged jeans		Drying cotton garments centrifuged at high speed in just 49 minutes
	Short ventilation for cotton and linen garments without blowing hot air		Gentle drying for shirts avoiding the formation of folds
	Drying synthetic, cotton or mixed garments		For synthetic fabrics, ironing is not required
	For synthetic fabrics, ironing is required		Super fast 30 min: a programme designed to wash small amounts of laundry fast, ideal for washing lightly soiled garments.
	Refresh: an ideal program to refresh the garments that have been kept for a long time indoors and eliminate unpleasant odors, without having to wash.		Shirts: a cycle to wash shirts in a short time with the utmost care, using a delicate spin for easy ironing.



Gym: Gym, a cycle designed for washing lightly soiled garments, ie sports wear, this is a fast wash which is also kind to fabrics.



Shows the phase of program: Shows the phase in which the program is being.